



Entrance Control Solutions





EDGE

Speed Gates

A combination of elegant design and advanced security. Quick access turnstile with 24V BLDC motor and optical safety sensor. Boot and times are between 0.7 and 1.5 seconds.





DESIGN

Combination of advanced security technology and elegance.

EDGE adds value to your modern corporate message with its striking design.

You can provide your visitors and employees with a safe environment with its elegant design gives a welcome message.

Based on your EDGE corporate colors or interior design it is customized and becomes an integral part of the lobby area.



VISION

Speed Gates

Combination of elegant design and advanced security. Swing speed gate with 24V brushless DC motor and up to 72 optical security sensors. Opening and closing time between 0,4 - 1.2 sec. As a part of interior design, Vision Speed Gate can be customized to match the corporate or interior colors and becomes an integrated part of the lobby area.





VISION FLAT

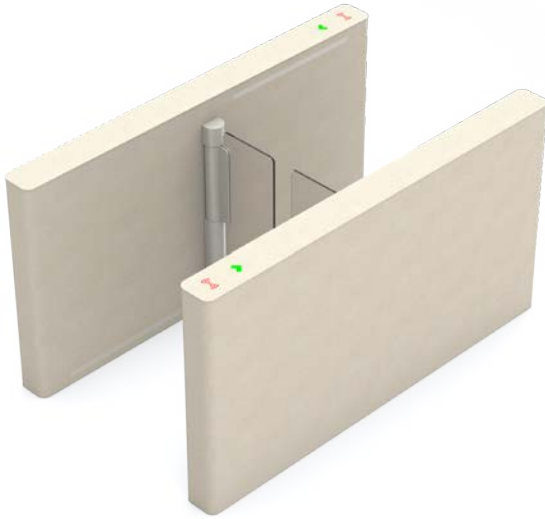

VISION SOLID



VISION BOLD



TOUCH

Speed Gates

An elegant & compact designed, swing speed gate with 24V BLDC motor. Opening and closing time between 0,7 - 1.5 sec.





ACCESS CONTROL INTEGRATION



Can be controlled by any kind of access control system through dry contact or COM ports.

Dept adjustable card reader & scanner installation area allows easy fitting.

Optional cuts on a glass top are available for surface mount readers, reader holders, or stands as well as standard or custom designed posts for access controller integration.

RFID Icon is positioned in the middle of the reader installation area to indicate the card reader position clearly.

An additional indicator on the top illuminates in red when the gate is locked and changes to green for confirmed passages or during the free passage.









Maxima MR-T

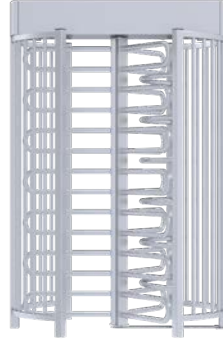
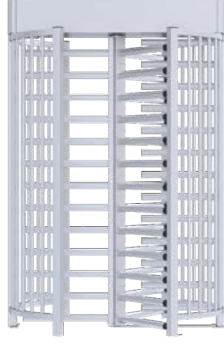
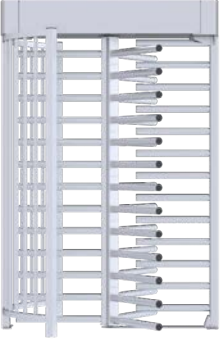

Maxima MR-F

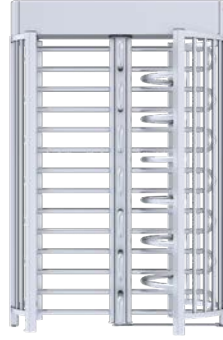
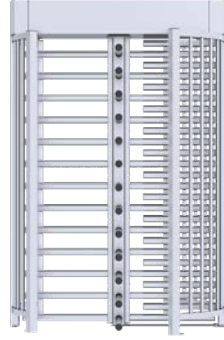
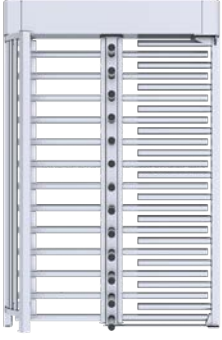

Maxima MA-T

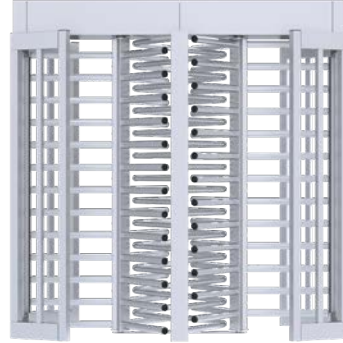
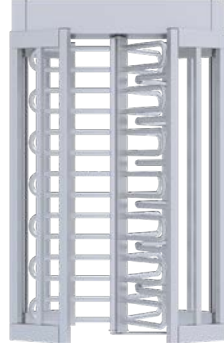
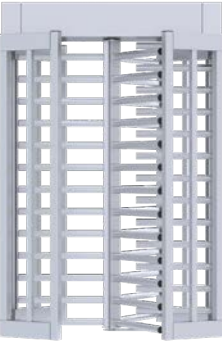

Maxima MA-F

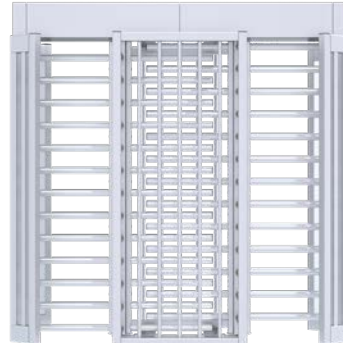
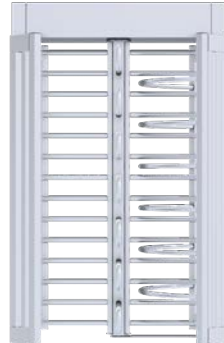

Maxima MC-T

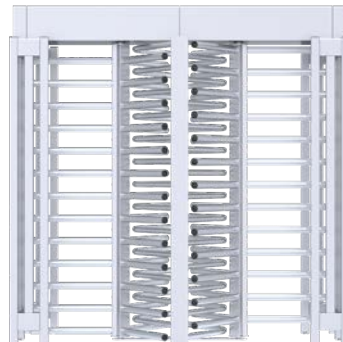
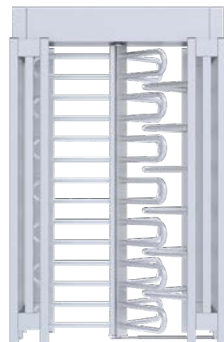
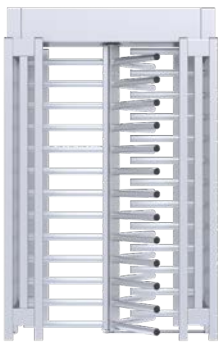



Maxima MC-F

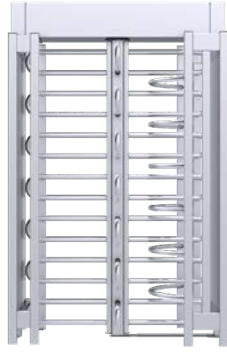
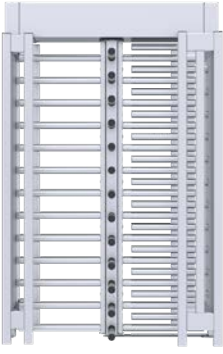

Maxima MX-T

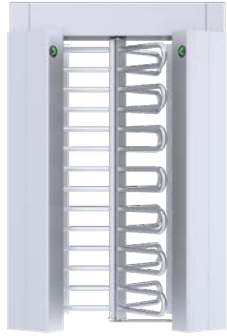
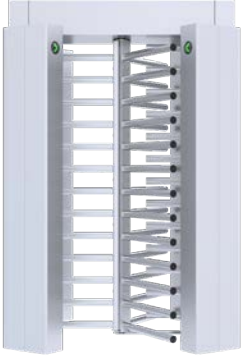

Maxima MX-F

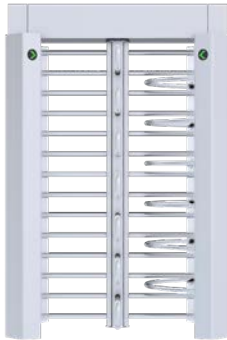
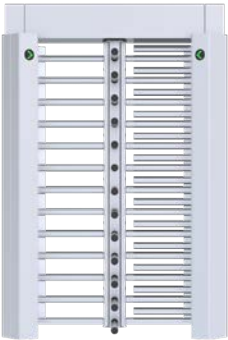

Maxima MB-T & MG-T



MAXIMA

Full Height Turnstile

Maxima MS

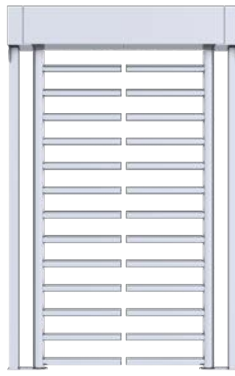
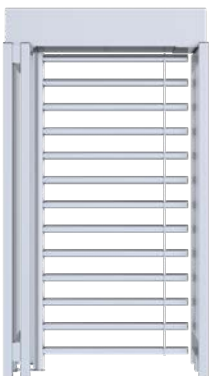

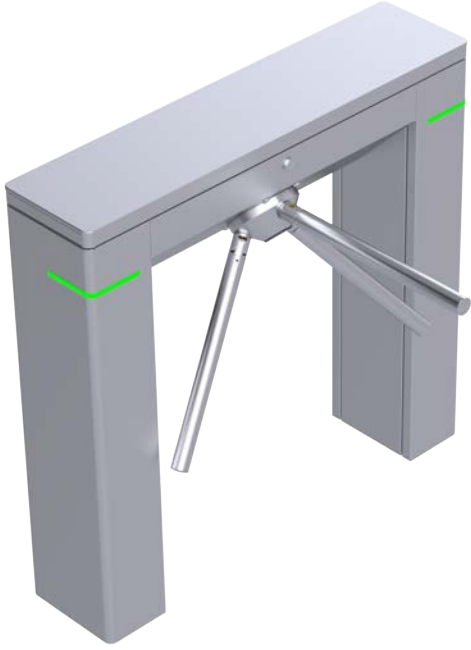

Durapod DT 100 ST



Durapod DT 100 BG



Durapod DT 200 ST



Durapod DT 200 BG



Durapod DT 300



Durapod DT 350



Durapod DT 400



Durapod DT 500



Durapod DT 510



Durapod DT 520



Durapod DT 590

DURAPOD

Tripod Turnstile







LTOP Series

Classic ellipse design. Concealed speed gate with 24V DC motor. Opening and closing time between 0.5 - 1.0 sec.



LTOP 111



LTOP 116



LTOP 301S



LTOP 301 STR

LTOP Speed Gates Turnstiles are designed to be used in places where luxury and prestige come to the fore, such as banks and holdings, and for fast and busy visitor personnel entrances. Architects and decorators are given the chance to make very different super models in LTOP Speed Gates Turnstiles. In addition to wood, marble, granite, leather, and various walnut, oak, and olive veneers are used to create very luxurious solutions and special decorations.

LTOP turnstiles form a corridor. In the middle of this corridor, there is a curtain/wing that prevents the passage of glass or plexiglass. This curtain/wing opens when the visitor reads their card. While the visitor passes by, the sensor sensors in the corridor allow the card reader to pass. However, if there is a leak during the sudden shutdown, if it will pose a danger to the person, the wing will not close, but the alarm will sound and warn security.



LS140 A combination of elegant design and advanced security. With a 24V BLDC motor and 14 optical safety sensors, opening and closing times are between 0.7 and 1.3 seconds. The LS 140 is customized to your corporate colors or interior
Speed Gates design, making it an integral part of the lobby area.





LS 130



LS 135



LS 170



LTT 303 E



LTT 303



LTT 303 AS



LTT 303 A



LTT 303 AD



LTT 313



LTT 313 E



LTT 313 ED



SG WMC

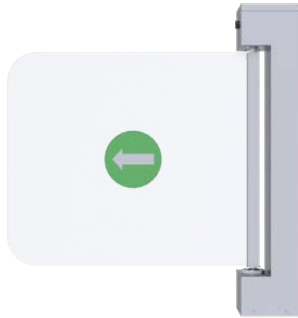

SG 112

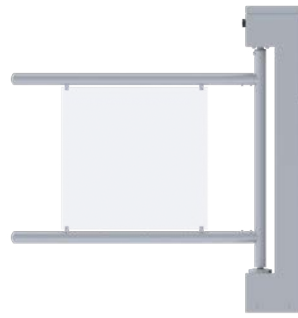

SG 212

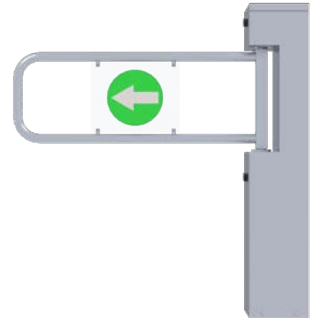

SG 312

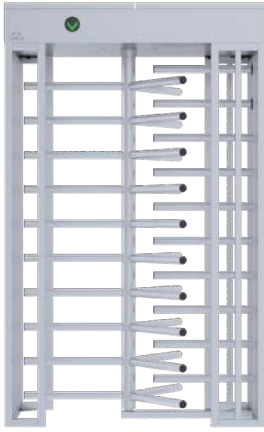

LTF 113



LTF 113 D

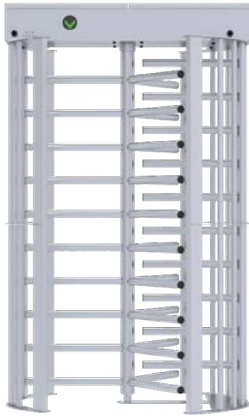

LTF 213



LTF 213 D

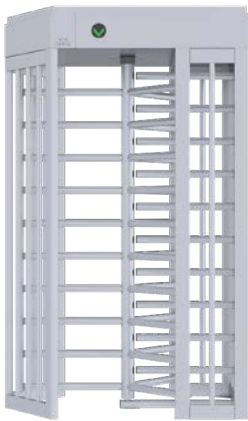

LTF 413



LTF 413 D

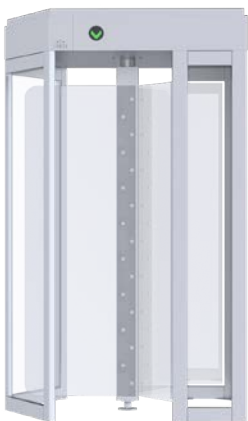

LTF 513



LTF 413 SG

LOGIC TURN
Value Series Entrance Control Products
that fits every budget



TRUSTED LEADER OF ENTR



ANCE CONTROL SOLUTIONS

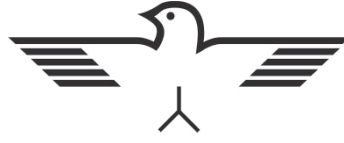

TANSA

SINCE 1962

